

# CATCHFISH 2.0

## ROBOTIC POOL CLEANER

**FOR ABOVE-GROUND POOLS  
& SEMI IN-GROUND POOLS**



**Congratulations on purchasing a  
Catchfish 2.0 Robotic Pool Cleaner.  
You have made an excellent choice.**

# THE STINGER ROBOTIC POOL CLEANER

FOR ABOVEGROUND POOLS



*Congratulations on purchasing a  
Stinger Robotic Pool Cleaner.  
You have made an excellent choice.*



## **READ THESE IMPORTANT OPERATING TIPS BEFORE USING YOUR UNIT**

Thank you for choosing a robotic pool cleaner. In order to achieve optimal performance, please read and follow these steps:

1. Cleaner filter bags should be thoroughly cleaned after each use or as often as needed to ensure cleaner's optimal performance.
2. Before using your cleaner and especially when opening the pool for the first time, remove larger items from the pool that may diminish the cleaner's performance. Clean filter bags frequently when pool is excessively dirty.
3. Cleaner may stop in the middle of the pool and reverse during cleaning cycle. This is a normal part of the programmed cycle.
4. **DO NOT** start cleaner out of the water. Power button should only be switched to "I" position when unit is submerged. The unit will automatically shut off, but it is best to put power switch in "O" position when unit completes cleaning.
5. The electric supply connection shall be made by a qualified electrician and comply with IEC 60364-1. It is recommended that the electric supply to this machine should include either a residual current device that will interrupt the supply if the leakage current to earth exceeds 30 mA for 30 ms or a device that will prove the earth circuit.
6. The power supply box (including safety isolated transformer) of swimming pool cleaner must be located at minimum 10 ft away from the pool edge.
7. The length of the supply cord of power supply box is maximum 3 ft.

### **2 YEAR LIMITED WARRANTY:**

First year 100% motor, power supply & cord. (Part numbers AC 20362, AC 21237 only).

Second year 50% of parts (Part numbers AC 20362, AC 21237 only).

One year 100% labor warranty (excludes trip charges and/ or bench fees).

Customer is responsible for shipping of unit and/ or parts to and from service center.

# CAUTION









1. This appliance can be used by children aged from 8 years and above and persons with reduced physical, sensory or mental capabilities or lack of experience and knowledge if they have been given supervision or instruction concerning use of the appliance in a safe way and understand the hazards involved. Children shall not play with the appliance. Cleaning and user maintenance shall not be made by children without supervision.
2. If the supply cord is damaged, it must be replaced by the manufacturer, its service agent or similarly qualified persons in order to avoid a hazard.
3. The pump must be supplied through a residual current device with GFCI.
4. Do not operate the cleaner when people are in the pool.
5. **CAUTION** — The control box of the appliance must be fixed to the ground.
6. **CAUTION** — The control box must be fixed at a minimum distance of 10 ft from the edge of the swimming operate the unit without fixing the control box first!
7. **CAUTION** — The appliance is only to be used with the power unit provided with the appliance.

## IMPORTANT SAFETY PRECAUTIONS

Attention User: This manual contains important information that will help you in operating and maintaining this pool cleaner. Please retain it for reference.

**WARNING** - Before installing this product, read and follow all warning notices and instructions which are included. Failure to follow safety warnings and instructions can result in severe injury, death, or property damage. Consumer Information and Safety service after installed, operated and maintained according to the information in this manual. Be sure to read and comply with all of the warnings and cautions.

## SAFETY PRECAUTIONS

 <b>DANGER</b>	<p>Risk of electrical shock or electrocution</p> <p>The electrical supply to this product must be installed in accordance with all applicable local codes and ordinances. Improper installation will create an electrical hazard which could result in death or serious injury to pool users or others due to electrical shock, and may also cause damage to property.</p>
 <b>WARNING</b>	<p>Do not play with cleaner or cable or apply to body. Can trap or tear hair or body parts. Cable can trip or entangle swimmers which could result in drowning.</p>
 <b>WARNING</b>	<p>The control box of appliance must be fixed securely on the ground wall. Never operate the unit without fixing.</p>
 <b>WARNING</b>	<p>To reduce the risk of injury, do not let children use or play with pool cleaner.</p>
 <b>CAUTION</b>	<p>Before installing the cleaner, understand cleaner coverage. The cleaner was not designed to automatically clean steps or to work under a solar cover. It was also not designed to do initial cleanup for a new pool installation.</p>
 <b>WARNING</b>	<p>Your cleaner should not be used while people are swimming in the pool.</p>
 <b>WARNING</b>	<p>The electric supply connection shall be made by a qualified electrician and comply with IEC 60364-1. It is recommended that the electric supply to this machine should include either a residual current device that will interrupt the supply if the leakage current to earth exceeds .3 Amps or a device that will prove the earth circuit.</p>
 <b>CAUTION</b>	<p>Do not allow swimmers in the pool while pool cleaner is operating.</p> <p>DO NOT switch on the pool cleaner if it is not immersed in the water.</p> <p>Operating the cleaner out of the water may cause severe damage and will result in loss of warranty. Always remember to turn the power supply "O" and unplug it from the power outlet before removing the cleaner from the pool.</p>

## **GENERAL INFORMATION**

Congratulations! You have got the most advanced automatic swimming pool cleaner. The Catchfish 2.0 is easy to use, and will help you clean your swimming pool. Operated according to this manual, your robot will clean your pool quickly and effectively.

### **READ AND FOLLOW ALL INSTRUCTIONS CAREFULLY BEFORE PUTTING YOUR CLEANER INTO USE**

- Deterioration, discoloration or brittleness of any pool finish can be caused over time separately by, or in combination with, age, incorrect pool water chemistry, improper installation, and other factors.
- Customer hereby disclaims any and all claims, and releases Manufacturer from any and all claims for damages to any pool plaster or vinyl liner in Customer's pool by reason of the use and/or operation of the Cleaner.
- Under no circumstances shall the Manufacturer be liable for any loss or damage, whether direct, consequential or incidental, arising out of the use or inability to use the cleaner in customer's pool.

## **FEATURES**

- The swimming pool cleaner independently scrubs, vacuums, and filters your pool.
- No installation, no attachments. Just drop it in and turn it on. It is completely automatic.
- Electronic Self-Diagnostics and overload Protection.
- It can be serviced in all shapes of pools.

# GENERAL OPERATING INSTRUCTIONS

Remove the CLEANER by placing the carton down and removing it from the box as shown. If the Caddy Cart is included, the CLEANER and the Power Supply will be pre mounted to the cart.

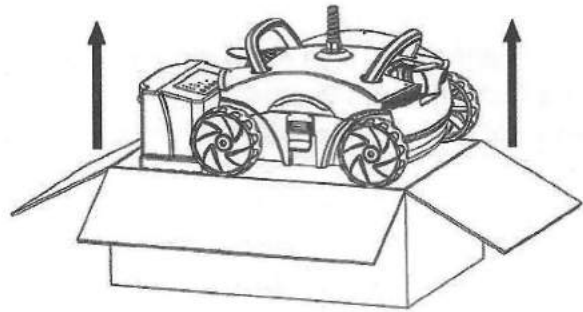

1. Select the nearest 115V~ voltage AC outlet protected by RCD.
2. The control box must be a minimum distance of 10 ft. from the edge of the swimming pool. Never operate the unit without fixing the control box first. The length of the standard **CLEANER** cable is 42 feet.

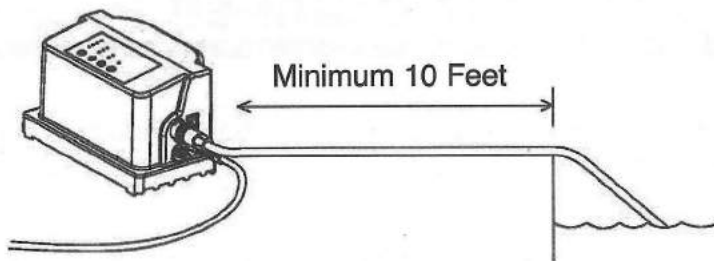

3. Connect the floating cable to the power supply control box. Use only the original Power Supply manufactured by Blue Torrent. Connect the floating cable to the control box as follow photo. Make sure they are connected correctly. (The fitting on the cleaner floating cable should be connected with the control box by turn at the clockwise direction).

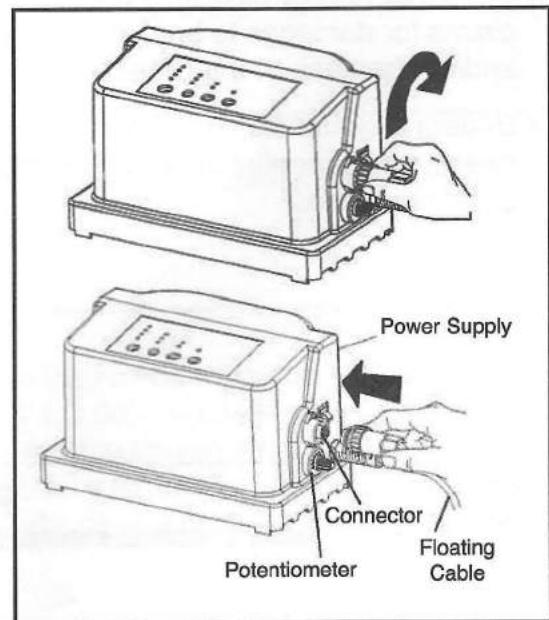
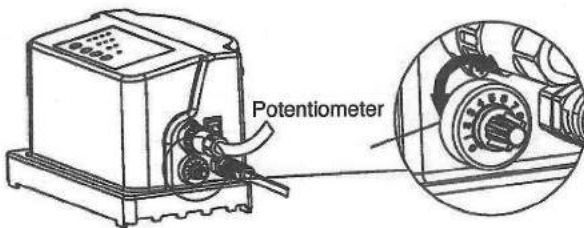

4. Place the **CLEANER** in the pool. It will slowly sink to the bottom of the pool as the air inside is released.
5. Connect the power supply to the **GFCI** protected outlet and switch it on. The **CLEANER** will run according to the procedures set to do the cleaning cycle. **CAUTION - DO NOT** switch on **CLEANER** when the **CLEANER** is out of water. This may result in damage to the pump and drive motor seals, which will **VOID** the warranty.
6. Choose the program and start:

- a. To turn the power supply **ON**, press and release the power button once. Then select the cycle mode you need, after 5 seconds, press **START** again.
- b. To turn the power supply **OFF**, press and release the power button. Light will turn **OFF**.
- c. The power supply has 2 settings. Each setting is determined by the pool size and cleanliness as well as for how long you would like to run the cleaning cycle.
- d. You have an option for **CYCLE I** and **CYCLE II**, **CYCLE I** is for **SMALL POOL** and **CYCLE II** is for **LARGE POOL**, press the button to get your correct setting.
- e. After setting, press **START** button to start the machine.
- f. If you would like to change the cycle mode while the machine is working, press **STOP** first, then select the cycle mode you need, after 5 seconds, press **START** again.

Should a second cleaning cycle be required, switch **OFF** the power supply for 5 seconds and restart.

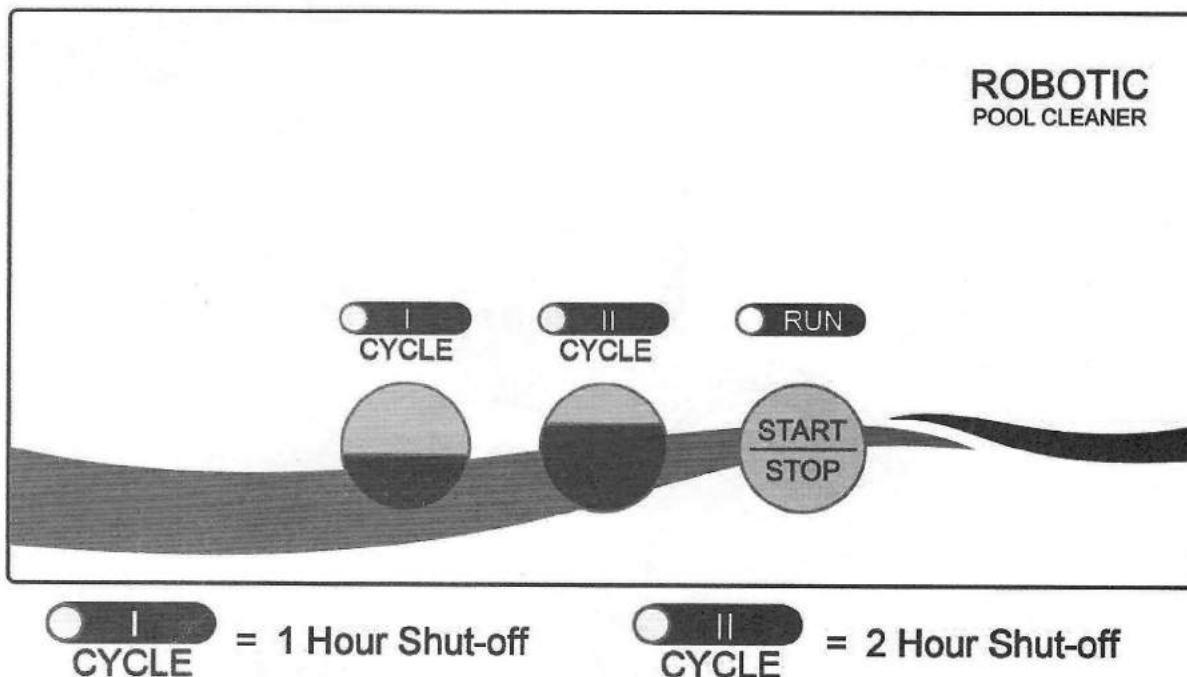

7. After the pool has been cleaned, switch **OFF** the power supply before removing the **CLEANER** from the pool.
8. Remove the **CLEANER** from the water at the shallow end of the pool by pulling the cable until the **CLEANER** reaches the surface. Then lift it out of the water using the handle, **NOT** the cable.
9. Do not operate the cleaner when people are in the pool.
10. The appliance is only to be used with the power unit provided with the appliance.

Caution: When pulling the cable, reel it in hand-over-hand, **DO NOT** reel it around your arm. The floating cable should be straight before and after work.

#### **DO NOT ENTER THE SWIMMING POOL WHEN THE CLEANER IS OPERATING**

The operating water temperature range for the **CLEANER** is 55° — 100°.

The operating depth of **CLEANER** is up to 6 Ft.

Remove the **CLEANER** from the pool after each use. Keeping the **CLEANER** permanently in the pool may result in additional service requirements.



# THE CATCHFISH 2.0 ROBOTIC POOL CLEANER PARTS

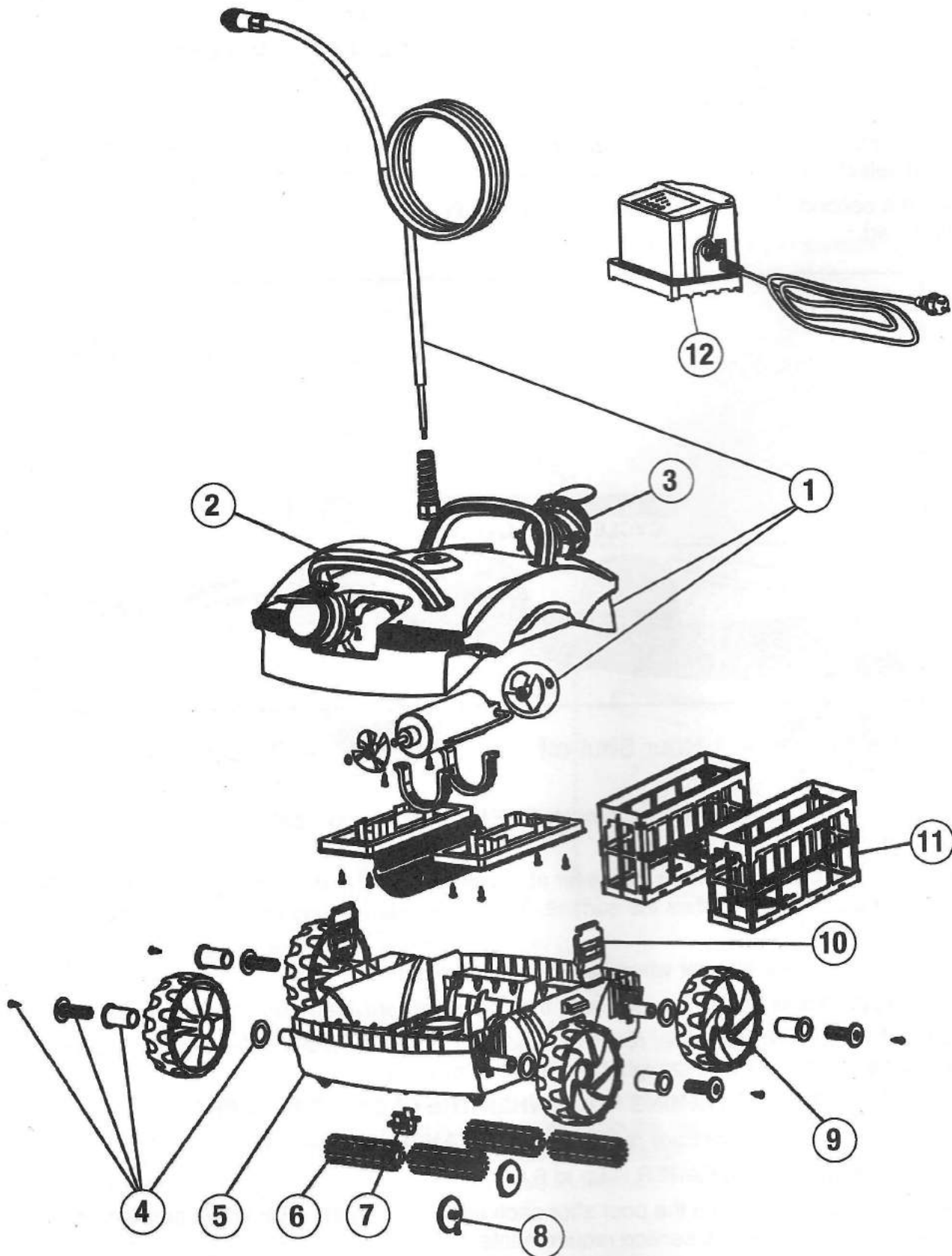

## THE CATCHFISH 2.0 ROBOTIC POOL CLEANER PARTS

<b>PART #</b>	<b>MODEL #</b>	<b>DESCRIPTION</b>	<b>QTY</b>
1	AC 20362	Catchfish 2.0 Cover Assembly	1
1	AC 20362	Catchfish 2.0 Cover Assembly	1
1	AC 20362	Catchfish 2.0 Cover Assembly	1
1	AC 20362	Catchfish 2.0 Cover Assembly	1
1	AC 20362	Catchfish 2.0 Cover Assembly	1
1	AC 20362	Catchfish 2.0 Cover Assembly	1
1	AC 20362	Catchfish 2.0 Cover Assembly	1
1	AC 20362	Catchfish 2.0 Cover Assembly	1
1	AC 20362	Catchfish 2.0 Cover Assembly	1
2	AC 20370	Catchfish 2.0 Handle	2
3	AC 20397	Catchfish 2.0 Universal Drain	2
4	AC 20567	Catchfish 2.0 Wheel Axle	2
5	AC 20605	Catchfish 2.0 Main Body Base	1
6	AC 20613	Catchfish 2.0 Roller	4
7	AC 20621	Catchfish 2.0 Roller Buckle	4
8	AC 21016	Catchfish 2.0 Anti-bump Wheel	2
9	AC 21024	Catchfish 2.0 Wheel	4
10	AC 21032	Catchfish 2.0 Clip	2
11	AC 21121	Catchfish 2.0 Filter Basket	2
12	AC 21237	Catchfish 2.0 Control Box	1

## DIRECTIONAL ANGLE ADJUSTMENT

- The cleaner has two outlets and the direction angle of each outlet is adjustable during running. If the Directional Angle adjustment angle is not satisfying, stop the cleaner, unscrew the screw as shown in the figure, manually adjust to a proper position (angle dimension:  $0 < 1 < 2$ ); after adjusting, tighten the screws.

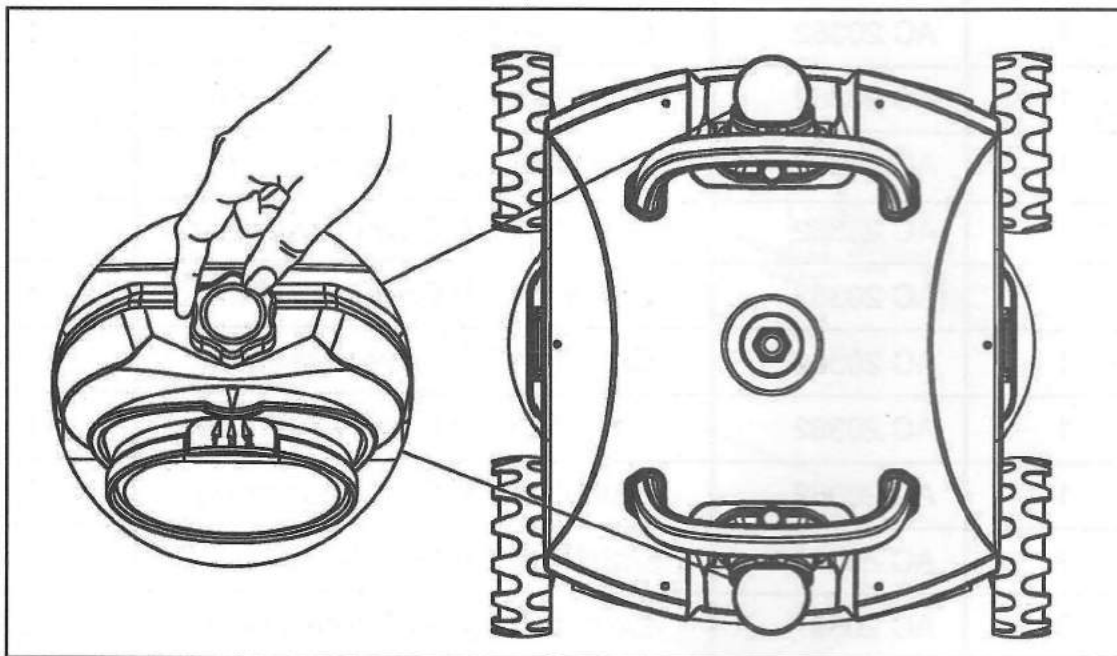

## MAINTENANCE

- Clean the filter bags after each use:

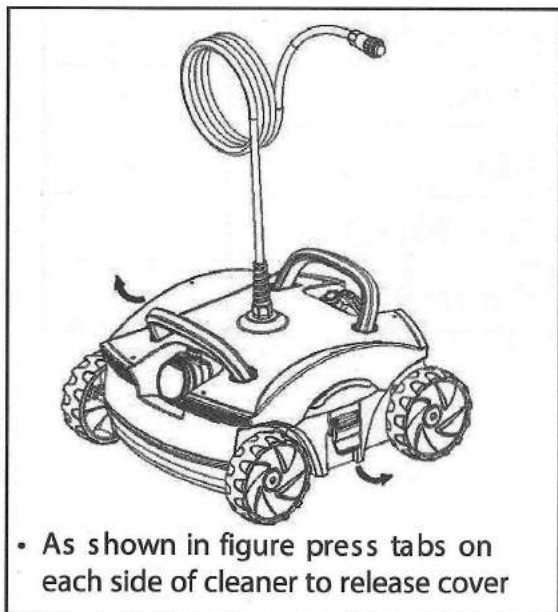

- As shown in figure press tabs on each side of cleaner to release cover



- Remove the cover, you will see the filter basket

## DIRECTIONAL ANGLE ADJUSTMENT

- The cleaner has two outlets and the direction angle of each outlet is adjustable during running. If the Directional Angle adjustment angle is not satisfying, stop the cleaner, unscrew the screw as shown in the figure, manually adjust to a proper position (angle dimension:  $0 < \alpha < 2$ ); after adjusting, tighten the screws.

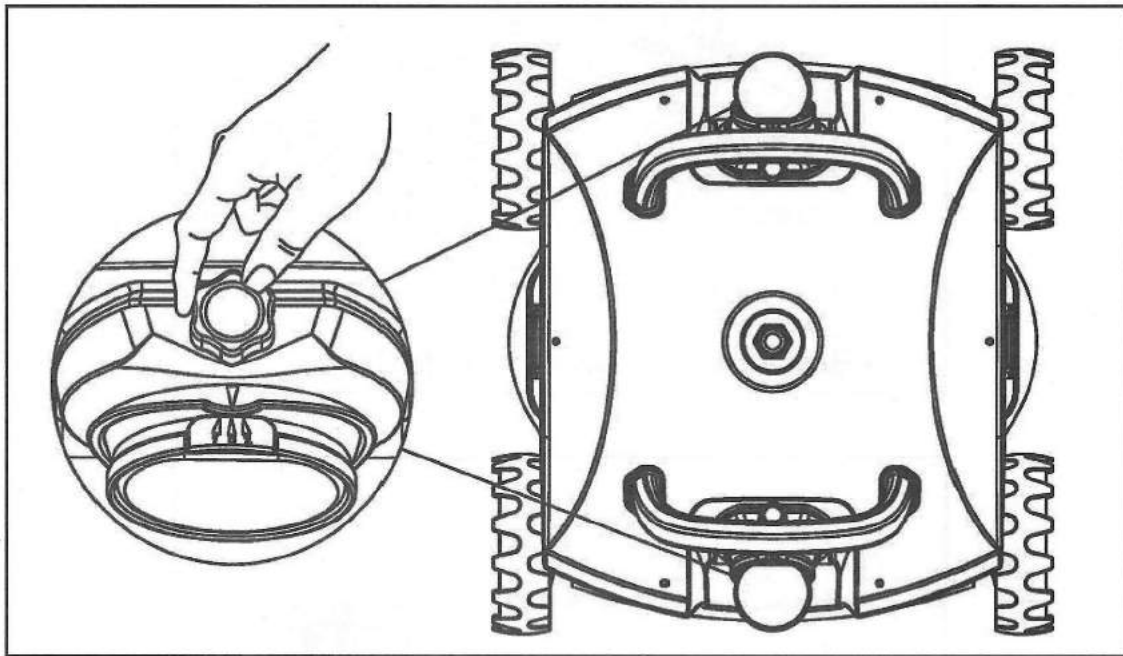

## MAINTENANCE

- Clean the filter bags after each use:

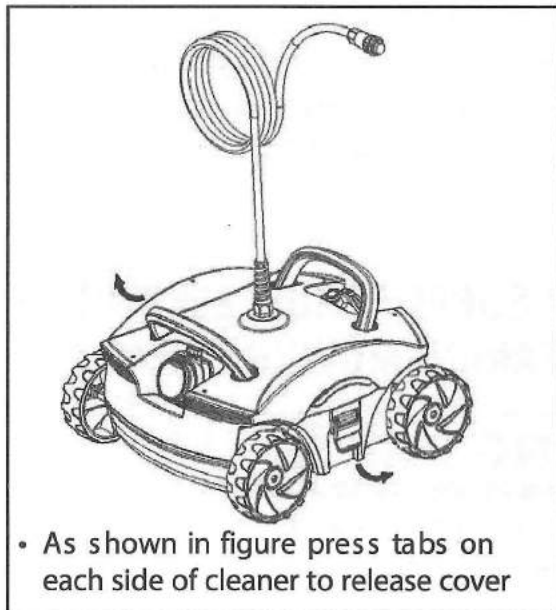

- As shown in figure press tabs on each side of cleaner to release cover

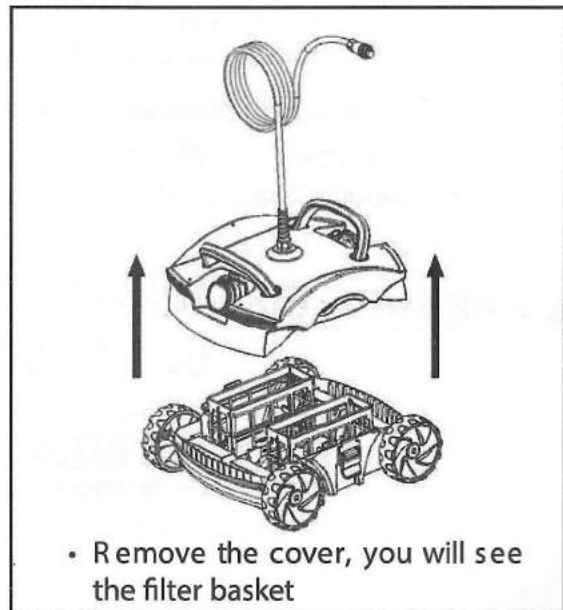

- Remove the cover, you will see the filter basket

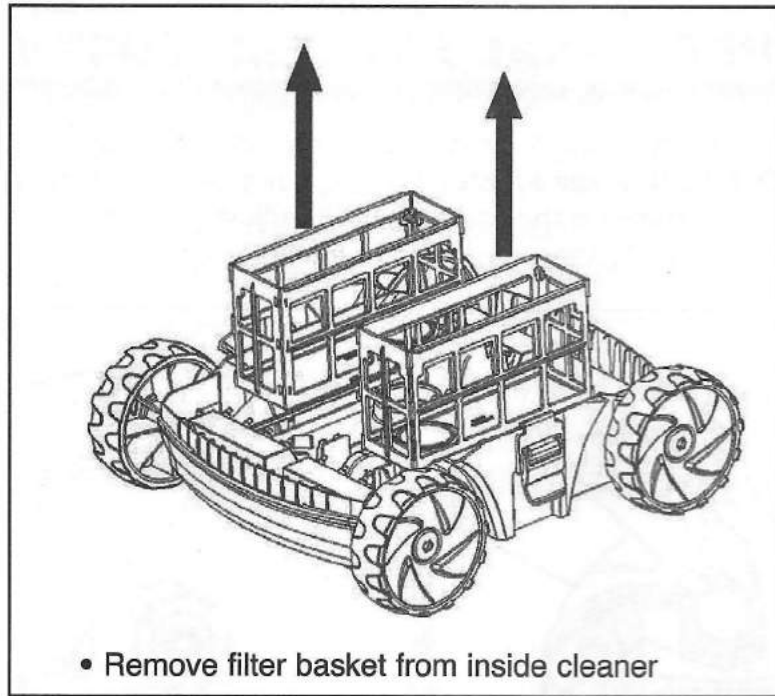

- Filter cleaning solution can be used to remove excessive dirt and/or sand.
- Remember: The cleaner your filter is, the more efficient the CLEANER will perform.
- Periodic Cleaning of Moving Parts

**⚠ WARNING** **DISCONNECT THE POWER SUPPLY FROM ELECTRICAL OUTLET BEFORE CLEANING MOVING PARTS**

### **CLEANING MOVING PARTS**

- Inspect the cleaner to ensure that no debris or hair has clogged the impeller.
- The impeller can be cleaned by spraying it with a garden hose.
- Remove any debris that has accumulated on the wheels

## STORAGE

- When out of the water, store the **CLEANER** in a dry, shady location at temperatures between 40°F — 80°F.

## CABLE CARE

- With continued use, the cable may become coiled (like a telephone cord). To correct this, periodically stretching the cord out in the sun should remove any cord twists.  
**IMPORTANT:** The cable should be checked periodically for any external damage.

## IMPORTANT TIPS

- Cleaning the filter bags after every use maximizes the unit's performance.
- Replace worn brushes.
- In a pool with usually high calcium content, more frequent cleaning of the filter is recommended.
- Save the **CLEANER'S** original carton for extended storage or shipping requirements when **CLEANER** require dealer service.
- **The sealed Motor Unit and the Power Supply contain no user-serviceable parts.**
- **Opening them will automatically VOID your warranty.**
- Remove items such as thermometer, toys and the like from the pool before operating the unit. Such items can jam the cleaner and cause damage to the unit and/or your pool.

## TROUBLESHOOTING

If **CLEANER** fails to pick up fine or heavy debris:

- Clean the filter bags. It may be clogged. A filter cleaning solution can be used to remove excessive dirt and/or sand.

If **CLEANER** starts working momentarily but then stops working:

- Impeller may be clogged or jammed with debris. Check and clean if necessary following the instructions in the maintenance section.
- There are 2 inlets located at bottom of the cleaner and near the brushes. Inlets located next to the brushes help collect debris such as leaves and sand better than single inlet.
- For the cleaners used in areas that have a lot of sand the cleaner may need to be rinsed with water at the main body base and may need rinsing at the cover and outlet to allow free operation.
- During the normal operating cycle of the cleaner, the unit will rise to allow the unit to clear obstacles, such as elevated main drains and stair steps.

If a cleaner has poor coverage of the pool in one cycle or only covers a small area, check the filter and clean if necessary and make sure the unit is not getting caught on drains, floor cleaning heads or toys. The user may try starting the cleaner in different locations to find the optimum cleaning location.

If debris falls from cleaner while removing from pool, it may be caused by filter overload, increase frequency of filter cleaning. Assure that there is no large debris blocking any of the two inlets. Large debris must be removed from the pool before using machine. If drain flaps are out of place or stuck by sand or leaves in the open position, the flaps can be snapped back into place, after cleaning the area.

Avoid dropping or throwing machine into pool. Place cleaner away from the pool wall but do not throw the cleaner in the pool.

If the location cord gets twisted which can be caused by the cleaner working for a long time, it can be straightened by laying the location cord at full length if possible in the sun; heat from the sun will help reduce the twisting.

If a high level of debris is visible through the outlet, remove cleaner quickly from the water to reduce the chance of the debris escaping the filter bag and reentering the pool.

## IMPORTANT SAFETY INSTRUCTIONS

The **CATCHFISH 2.0 CLEANER** automatic swimming pool vacuum cleaner has been manu-factured with the highest degree of care and concern for safety. We suggest the following safety precautions become part of your pool safety regulations:

# THE STINGER/MYBOT AUTOMATIC POOL CLEANER CONTROL BOX

To optimize the life of the Cleaner Control Box we suggest hanging the Control Box from a fence, shed or a post.

**SEE PICTURE BELOW**

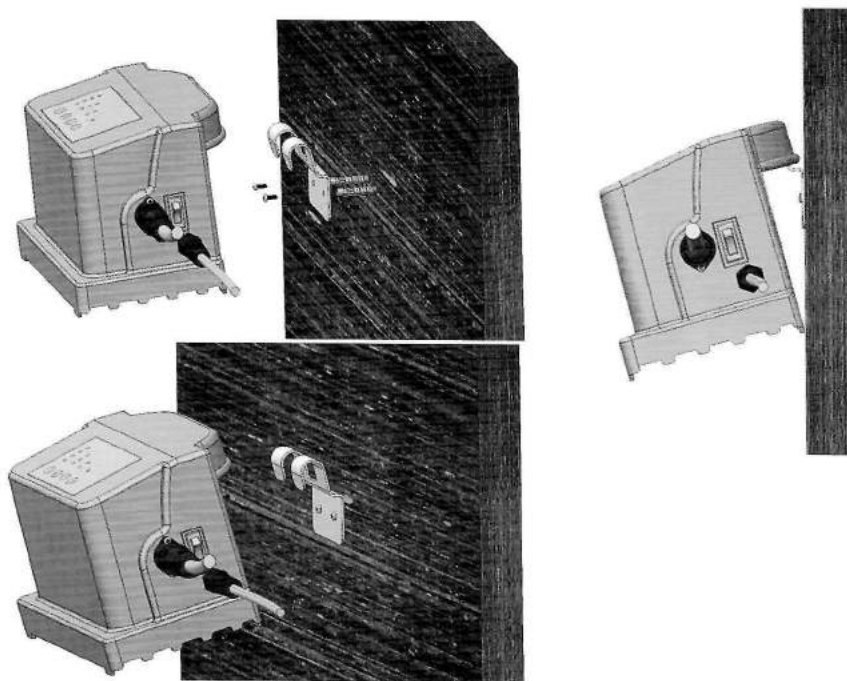

Simply attach the bracket to a solid surface using the hardware provided. Once the bracket is attached you can hang the Controller Box. This will eliminate the potential problem of the Control Box standing in water.